

Junior Cert Higher Level Constructions:

1. Bisector of an angle, using only a compass and a straight edge.
2. Perpendicular bisector of a segment, using only a compass and a straight edge.
3. Line perpendicular to a given line l , passing through a given point not on l .
4. Line perpendicular to a given line l , passing through a given point on l .
5. Line parallel to a given line, through a given point.
6. Division of a line segment into 2 or 3 equal parts, without measuring it.
7. Division of a line segment into n equal segments, without measurement.
8. Line segment of a given length on a given ray.
9. Angle of a given number of degrees with a given ray as one arm.
10. Triangle, given the length of three sides. (SSS)
11. Triangle, given two sides and the included angle. (SAS)
12. Triangle, given two angles and the common side. (ASA)
13. Right-angled triangle, given length of hypotenuse and one other side. (RHS)
14. Right-angled triangle, given one side and one of the acute angles.
15. Rectangle, given side lengths.

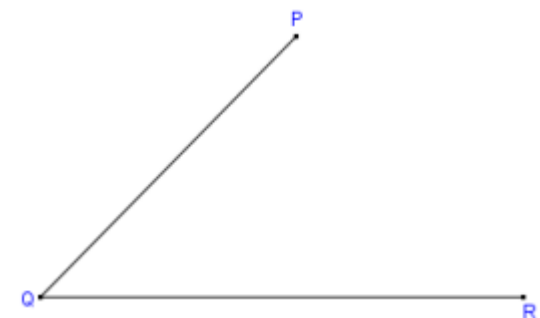
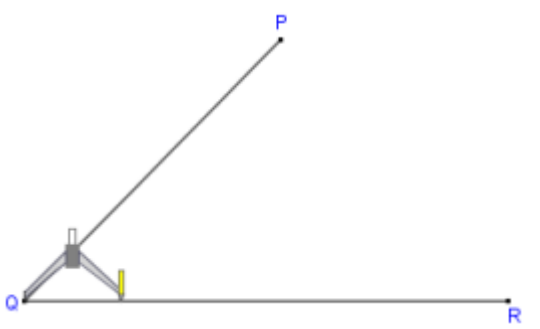
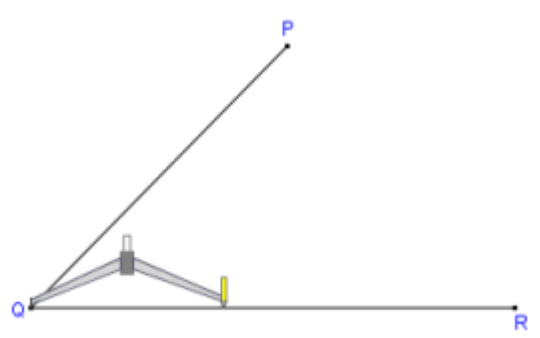
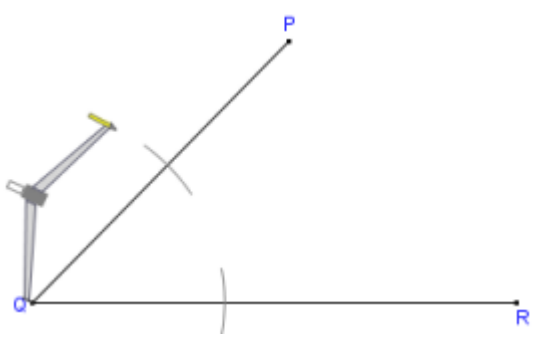
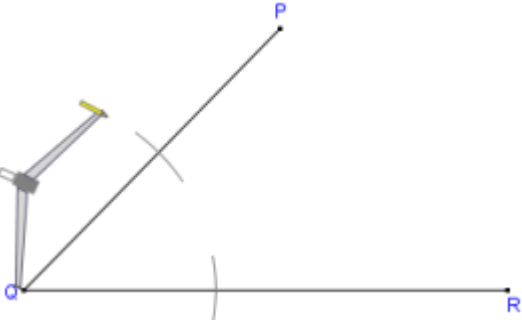
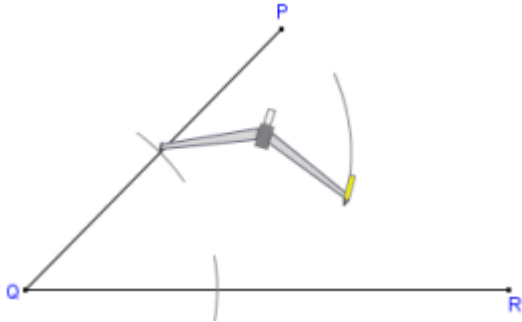
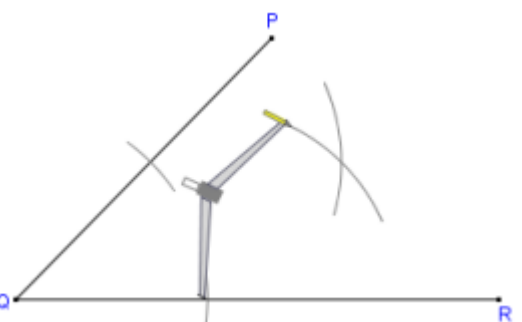
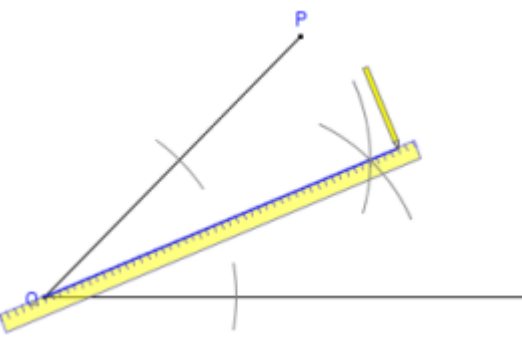

1. Bisect an angle:

After doing this	Your work should look like this
Start with angle PQR that we will bisect.	
1. Place the compass point on the angle's vertex Q.	
2. Adjust the compass to a medium wide setting. The exact width is not important.	
3. Without changing the compass width, draw an arc across each leg of the angle.	

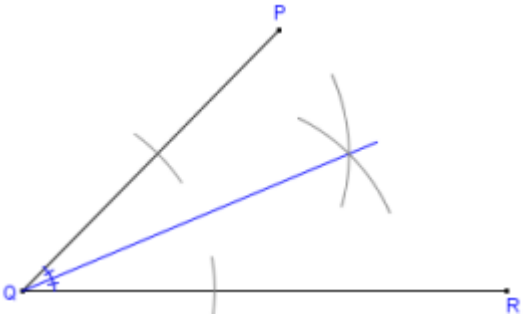
After doing this	Your work should look like this
<p>4. The compass width can be changed here if desired. Recommended: leave it the same.</p>	
<p>5. Place the compass on the point where one arc crosses a leg and draw an arc in the interior of the angle.</p>	
<p>6. Without changing the compass setting repeat for the other leg so that the two arcs cross.</p>	
<p>7. Using a straightedge or ruler, draw a line from the vertex to the point where the arcs cross.</p>	

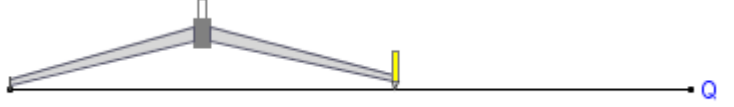
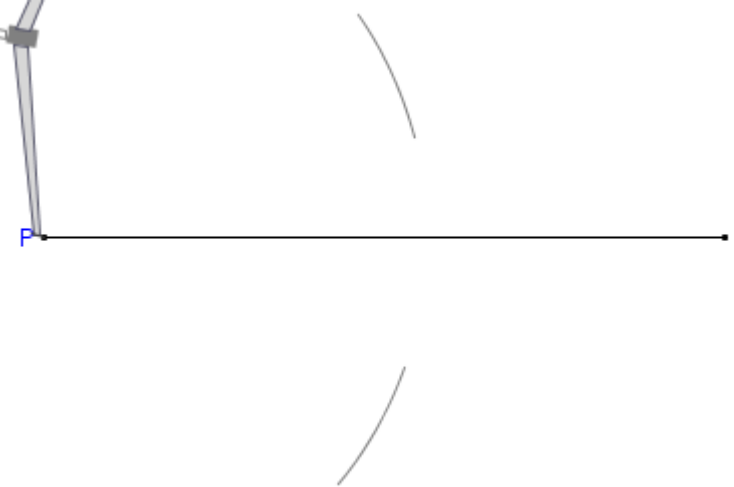

After doing this	Your work should look like this
Done. This is the bisector of the angle $\angle PQR$.	

2. Perpendicular bisector of a line segment:

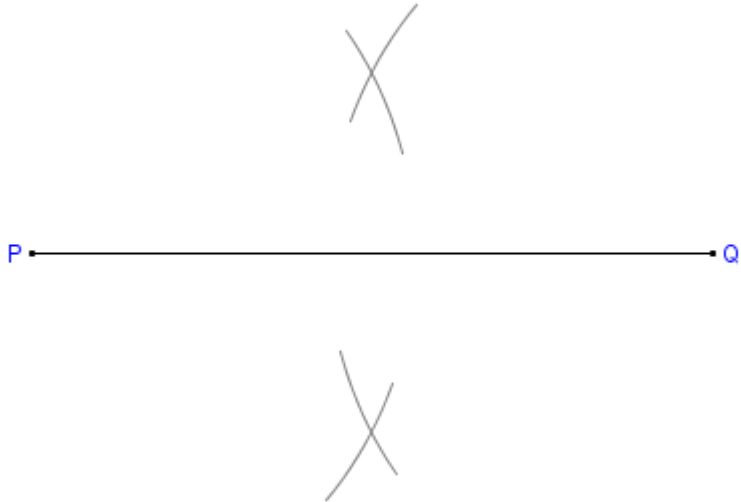
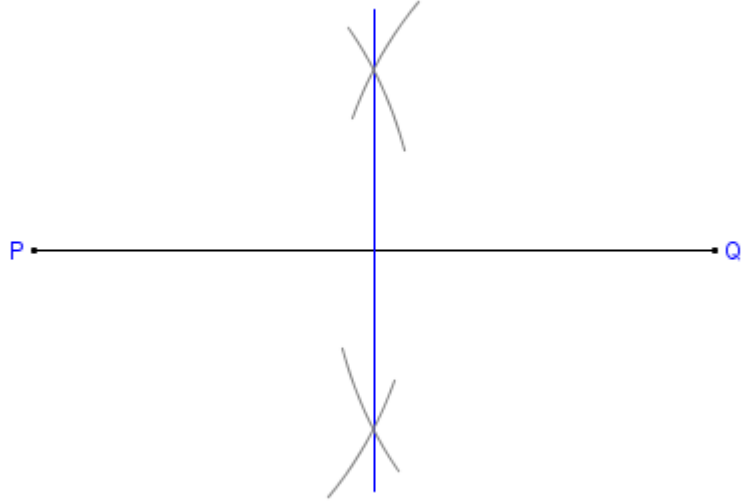
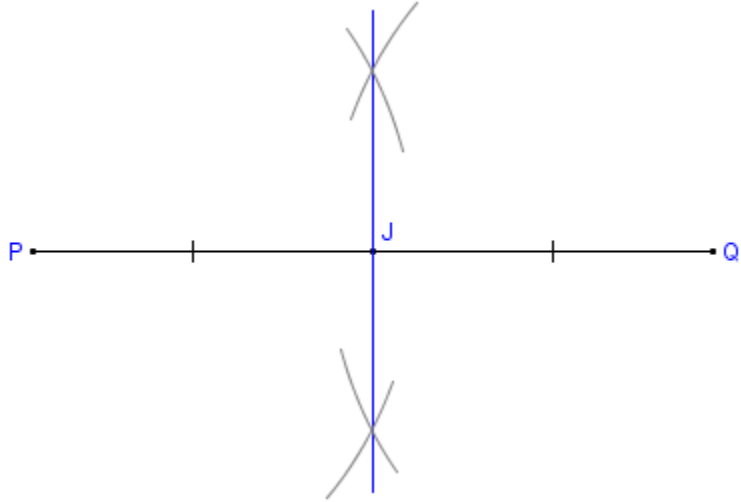
	After doing this	Your work should look like this
	Start with a line segment PQ.	
1	Place the compass on one end of the line segment.	
2	Set the compass width to a approximately two thirds the line length. The actual width does not matter.	
3	Without changing the compass width, draw an arc above and below the line.	

<p>4</p>	<p>Again without changing the compass width, place the compass point on the the other end of the line. Draw an arc above and below the line so that the arcs cross the first two.</p>	
<p>5</p>	<p>Using a straightedge, draw a line between the points where the arcs intersect.</p>	
<p>6</p>	<p>Done. This line is perpendicular to the first line and bisects it (cuts it at the exact midpoint of the line).</p>	

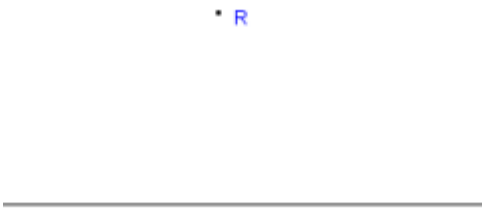
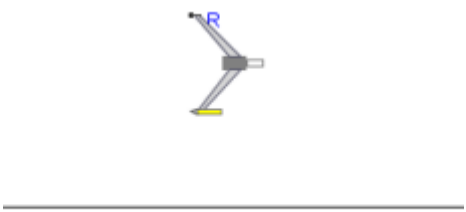
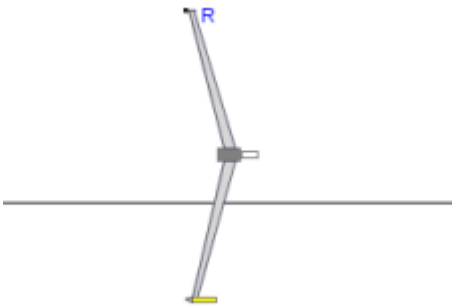
3. Perpendicular to a line through a point: (Higher Level)

	After doing this	Your work should look like this
	Start with a line and point R which is not on that line.	
Step 1	Place the compass on the given external point R.	
Step 2	Set the compass width to a approximately 50% more than the distance to the line. The exact width does not matter.	
Step 3	Draw an arc across the line on each side of R, making sure not to adjust the compass width in between. Label these points P and Q	

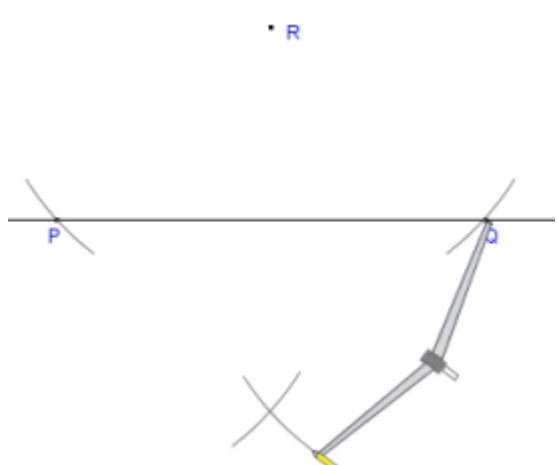
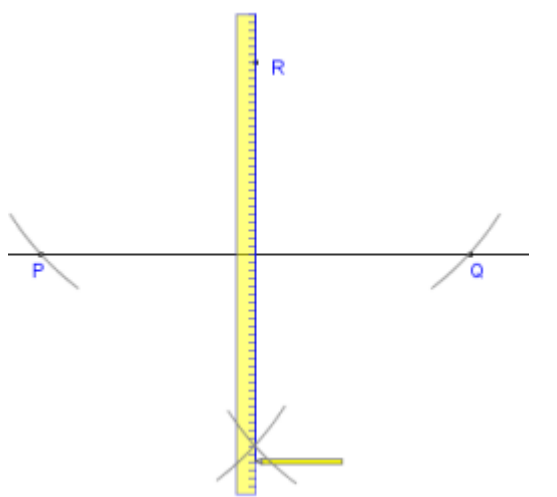
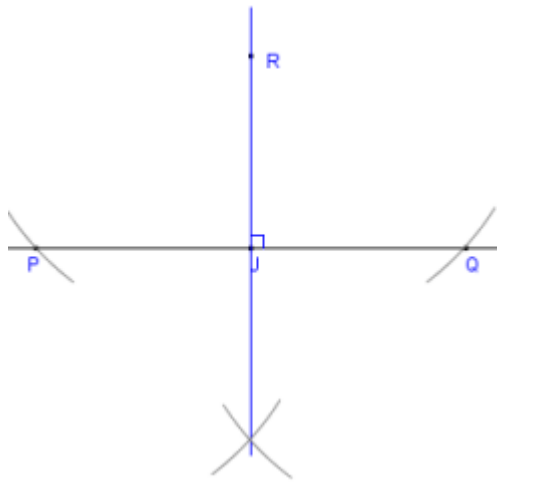
	After doing this	Your work should look like this
Step 4	<p>At this point, you can adjust the compass width. Recommended: leave it as is.</p> <p>From each point P,Q, draw an arc below the line so that the arcs cross.</p>	
Step 5	<p>Place a straightedge between R and the point where the arcs intersect. Draw the perpendicular line from R to the line, or beyond if you wish.</p>	
Step 6	<p>Done. This line is perpendicular to the first line and passes through the point R. It also bisects the segment PQ (divides it into two equal parts)</p>	

4. Perpendicular at a point on a line:

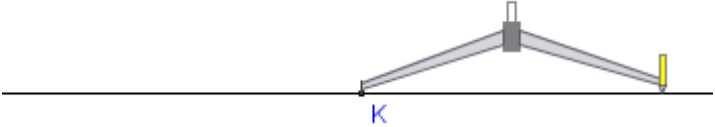
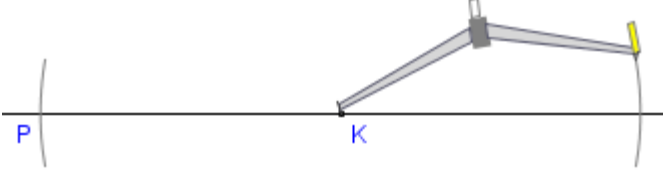
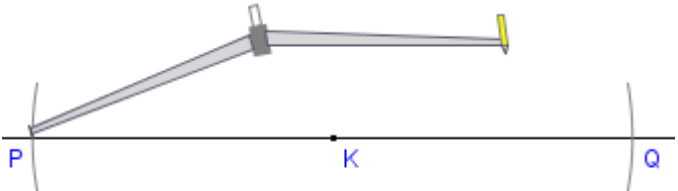
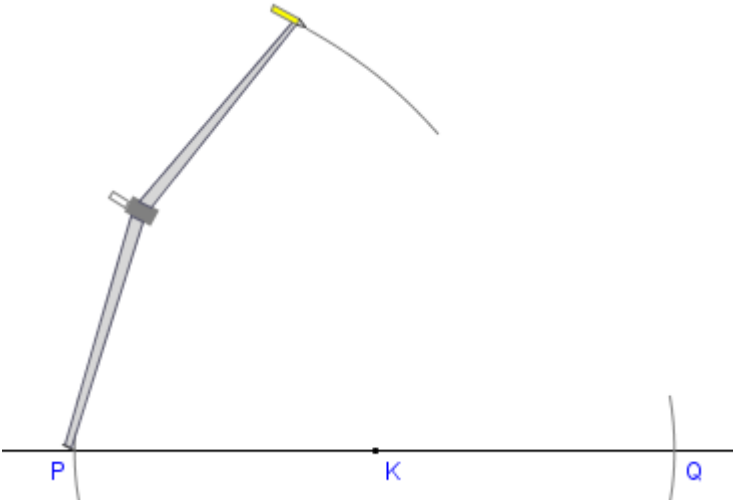
	After doing this	Your work should look like this
	Start with a line and point K on that line.	
1	Set the compass width to a medium setting. The actual width does not matter.	
2	Without changing the compass width, mark a short arc on the line at each side of the point K, forming the points P,Q. These two points are thus the same distance from K.	
3	Increase the compass to almost double its width (again the exact setting is not important).	
4	From P, mark off a short arc above K	

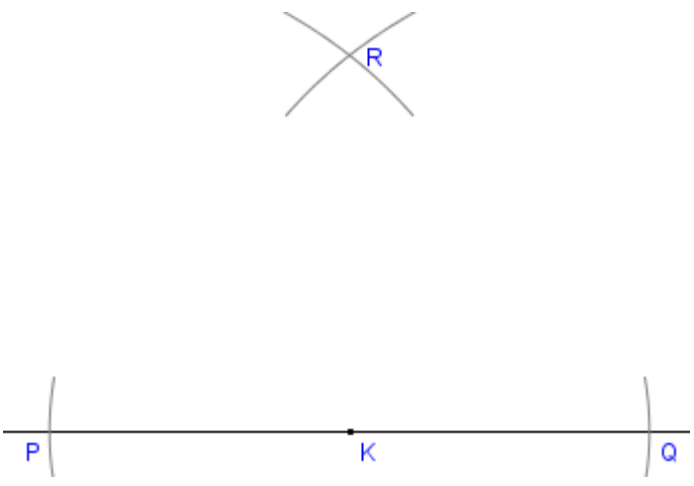
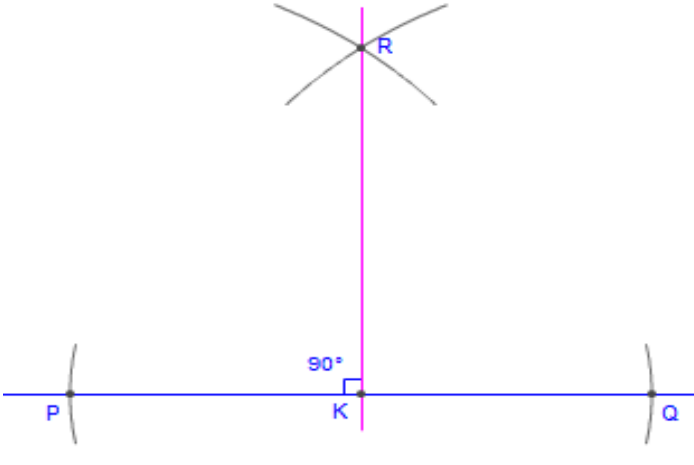

	After doing this	Your work should look like this
5	Without changing the compass width repeat from the point Q so that the the two arcs cross each other, creating the point R	 <p>The diagram shows a horizontal line segment with endpoints P and Q. A point K is marked at the midpoint of the segment. Two arcs are drawn above the line, one centered at P and one centered at Q, intersecting at point R.</p>
6	Using the straight edge, draw a line from K to where the arcs cross.	 <p>The diagram shows the same setup as in step 5. A vertical line is drawn from point K to point R. A right-angle symbol is drawn at point K, and the text '90°' is written next to it, indicating that the line KR is perpendicular to the line segment PQ.</p>
7	Done. The line just drawn is a perpendicular to the line at K	

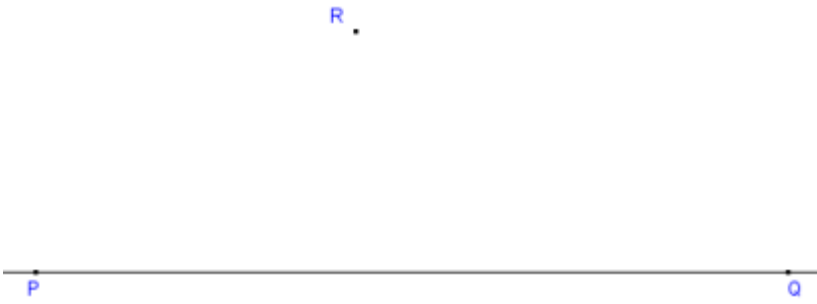
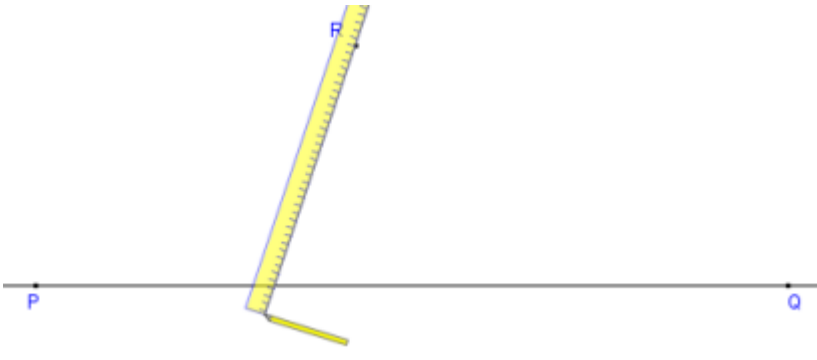
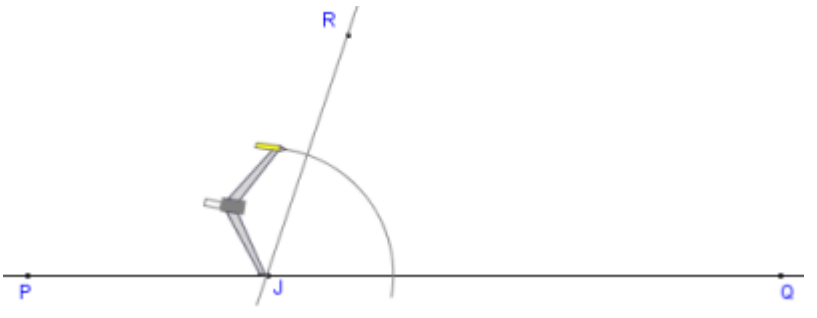
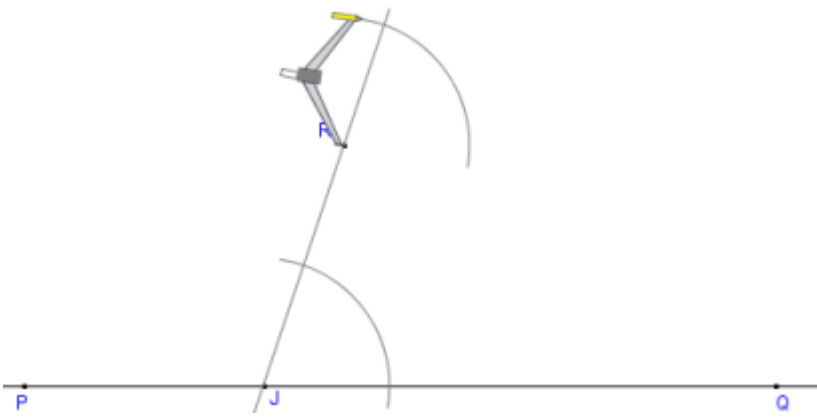
5. Line Parallel to a given line through a given point:

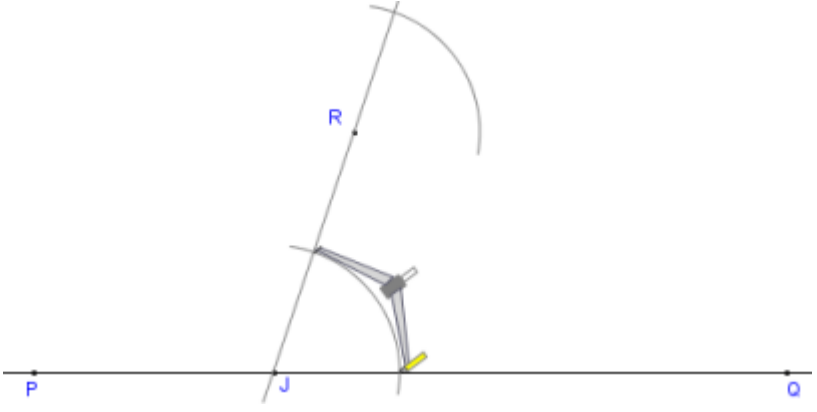
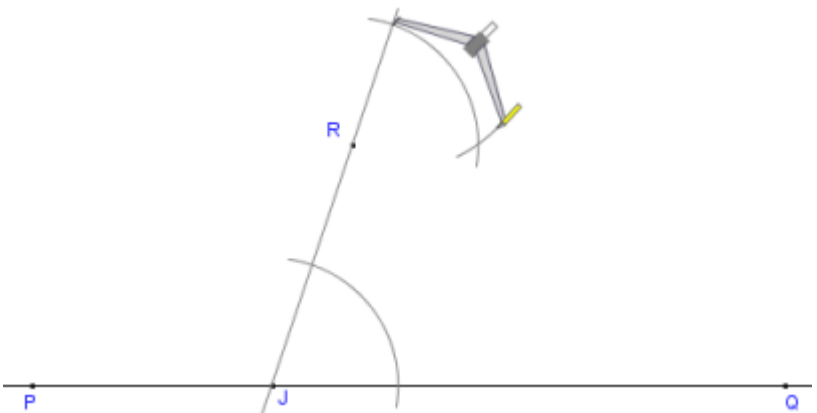
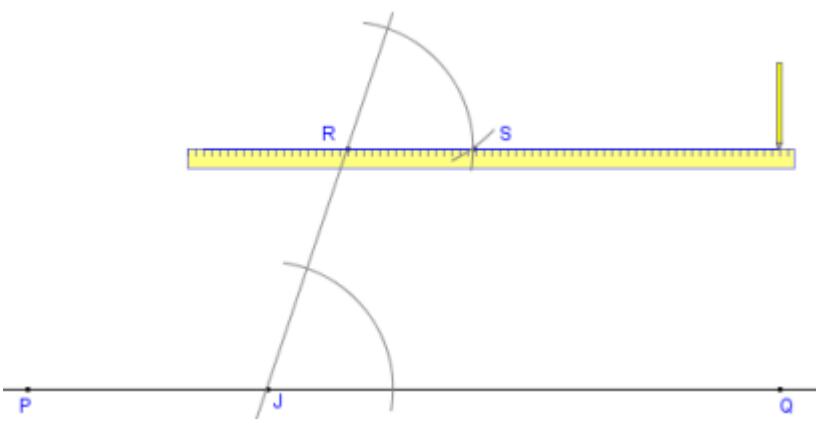
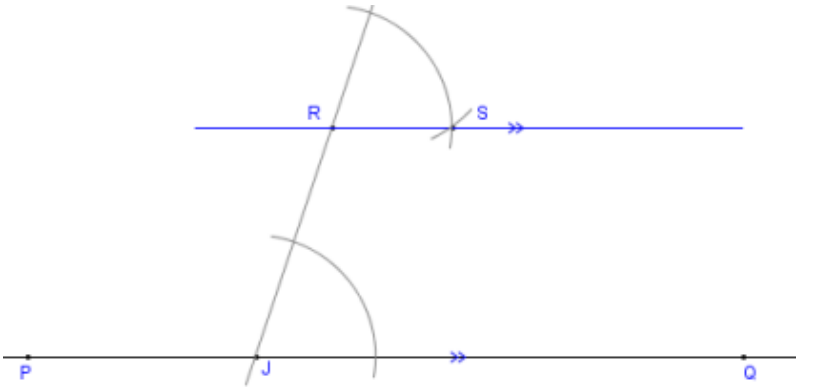

After doing this	Your work should look like this
Start with a line PQ and a point R off the line.	 <p>A horizontal line is drawn with endpoints labeled P and Q. A point labeled R is marked above the line.</p>
1. Draw a transverse line through R and across the line PQ at an angle, forming the point J where it intersects the line PQ. The exact angle is not important.	 <p>A yellow ruler is drawn as a transverse line passing through point R. It intersects the horizontal line PQ at point J.</p>
2. With the compass width set to about half the distance between R and J, place the point on J, and draw an arc across both lines.	 <p>A compass is centered at point J. An arc is drawn that passes through point R on the transverse line.</p>
3. Without adjusting the compass width, move the compass to R and draw a similar arc to the one in step 2.	 <p>The compass is now centered at point R. A second arc is drawn, intersecting the horizontal line PQ.</p>

After doing this	Your work should look like this
<p>4. Set compass width to the distance where the lower arc crosses the two lines.</p>	
<p>5. Move the compass to where the upper arc crosses the transverse line and draw an arc across the upper arc, forming point S.</p>	
<p>6. Draw a straight line through points R and S.</p>	
<p>Done. The line RS is parallel to the line PQ</p>	

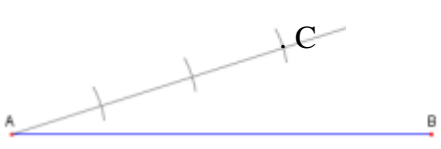
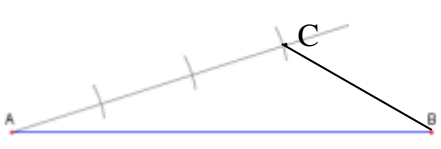
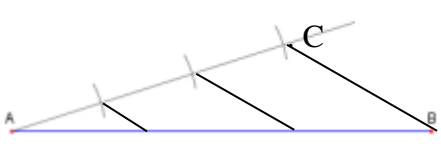
6. Divide a line segment into 2 or 3 equal parts:

	After doing this	Your work should look like this
	Start with a line segment AB that we will divide up into 2 or 3 (in this case) equal parts.	
Step 1	From point A, draw a line segment at an angle to the given line, and about the same length. The exact length is not important.	
Step 2	Set the compass on A, and set its width to a bit less than one third of the length of the new line.	
Step 3	Step the compass along the line, marking off 2/3 arcs (depending on how many segments you want). Label the last one C.	
Step 4	Using a ruler, join C to B.	
Step 5	Using a set square and a ruler, construct two more lines that are parallel to CB from each of the other two arcs.	
Step 6	Line AB should now be split into 2 or 3 equal parts.	

7. Divide a line segment into n equal parts: (Higher Level)

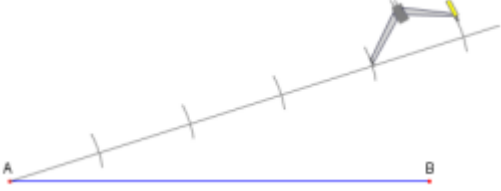
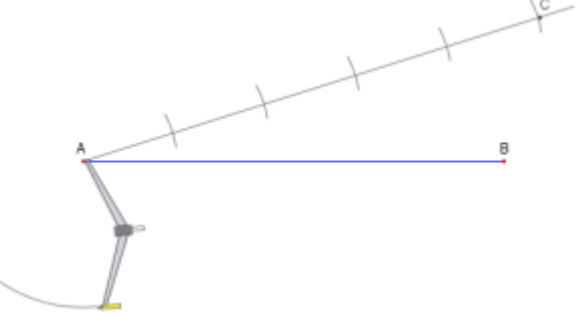
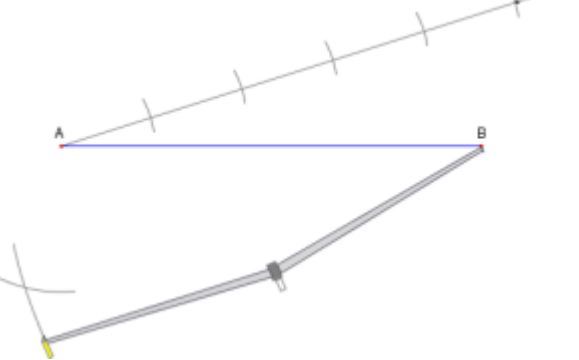
	After doing this	Your work should look like this
	Start with a line segment AB that we will divide up into 5 (in this case) equal parts.	
Step 1	From point A, draw a line segment at an angle to the given line, and about the same length. The exact length is not important.	
Step 2	Set the compass on A, and set its width to a bit less than one fifth of the length of the new line.	
Step 3	Step the compass along the line, marking off 5 arcs. Label the last one C.	
Step 4	With the compass width set to CB, draw an arc from A just below it.	
Step 5	With the compass width set to AC, draw an arc from B crossing the one drawn in step 4. This intersection is point D.	

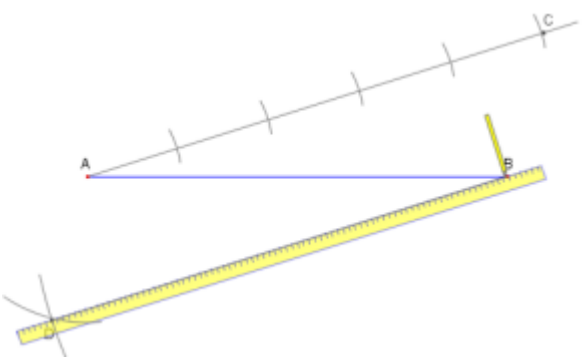
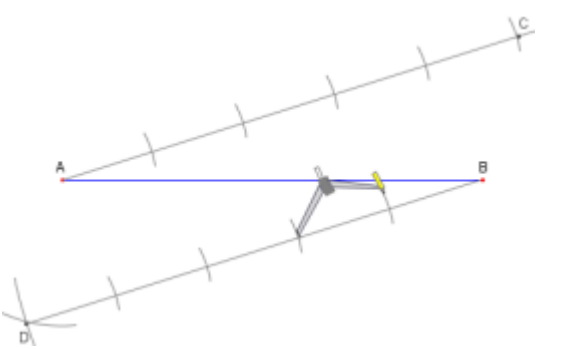
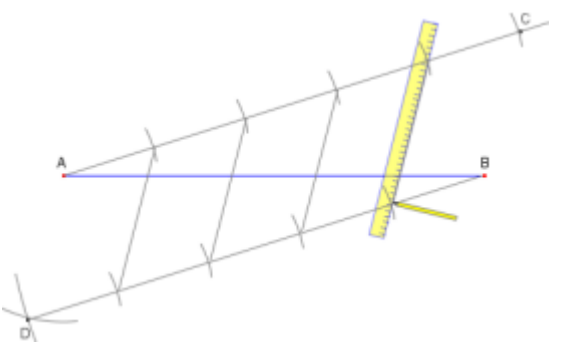
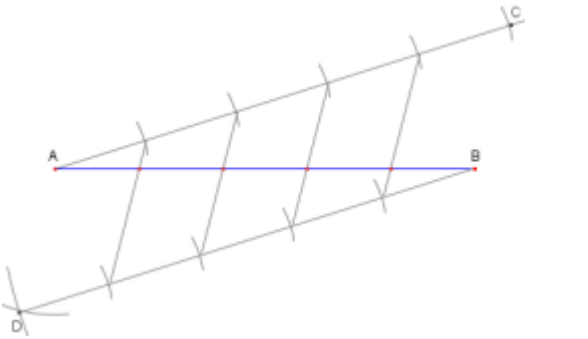
	After doing this	Your work should look like this
Step 6	Draw a line from D to B.	
Step 7	Using the same compass width as used to step along AC, step the compass from D along DB making 4 new arcs across the line	
Step 8	Draw lines between the corresponding points along AC and DB.	
Step 9	Done. The lines divide the given line segment AB in to 5 congruent parts.	

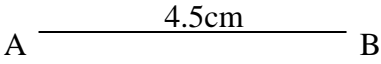
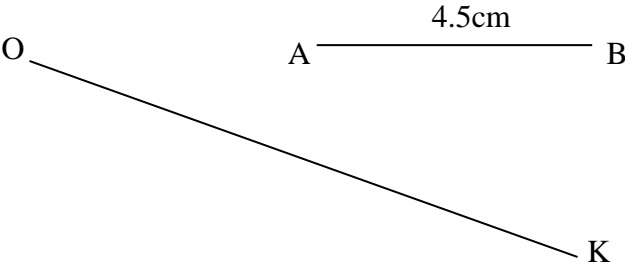
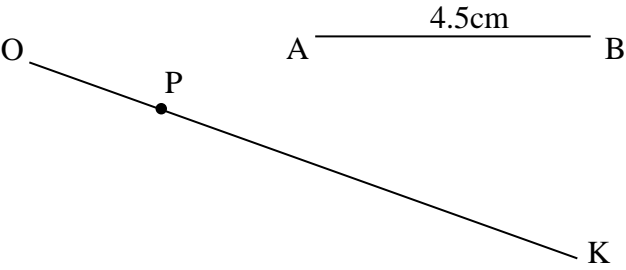
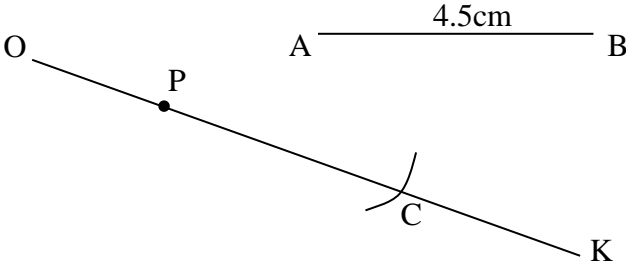
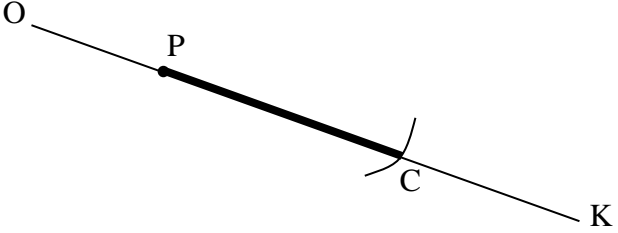

8. Line segment of a given length on a given ray:

	After doing this	Your work should look like this
	Draw a line segment [AB] of the required length with a ruler.	
1	Draw a ray [OK], the length of which should be greater than 4.5cm....about 8cm.	
2	Mark off a point P on the ray [OK].	
3	Using the line segment [AB], set your compass width to the length of the line [AB]. Place your compass needle at P and swing an arc on the ray [OK]. Label the intersection of the arc and the ray as C.	
4	Join P to C.	

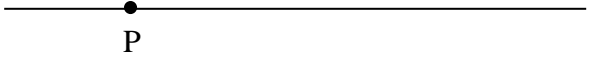
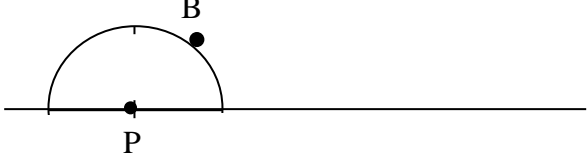
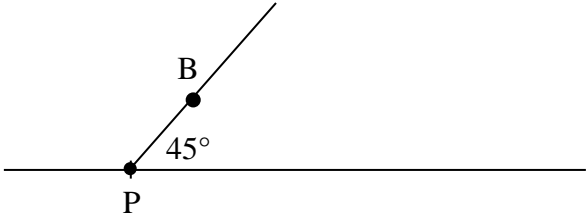
9. Angle of a given number of degrees with a given ray as one arm:

	After doing this	Your work should look like this
	Draw a line m.	
1	Mark a point on the line m and label as P.	
2	Place your protractor at the point P and mark off the required angle e.g. 45° and label it B.	
3	Using a ruler, draw a line through P and B. The angle should be the required angle.	

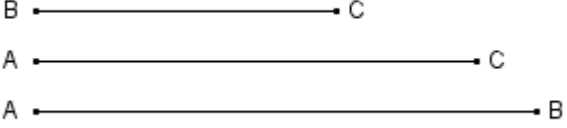
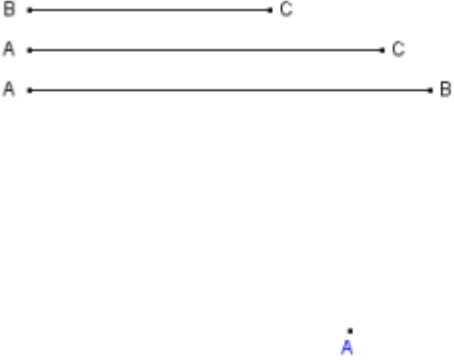
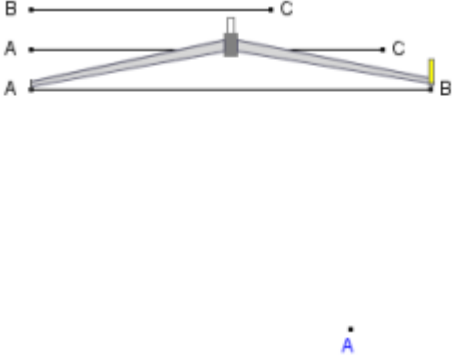

10. Triangle given three sides (SSS):

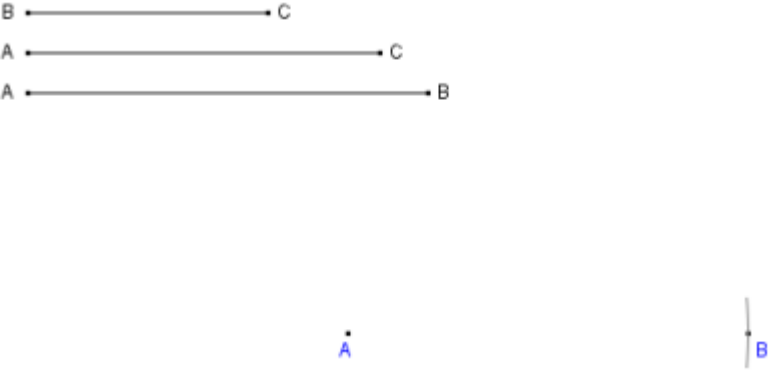
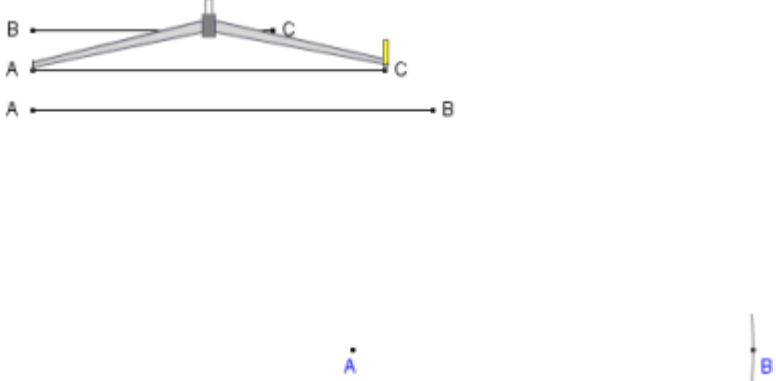
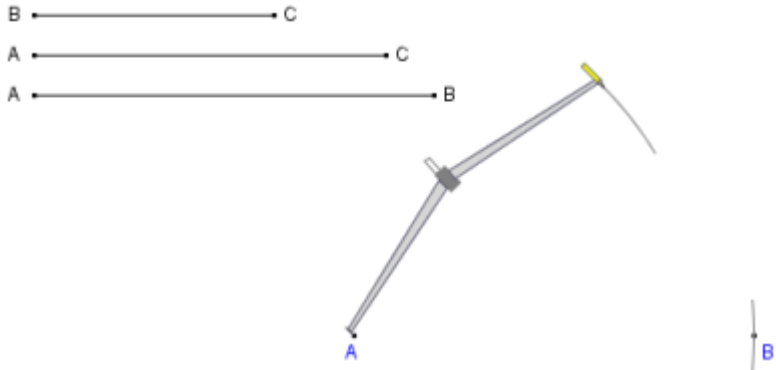
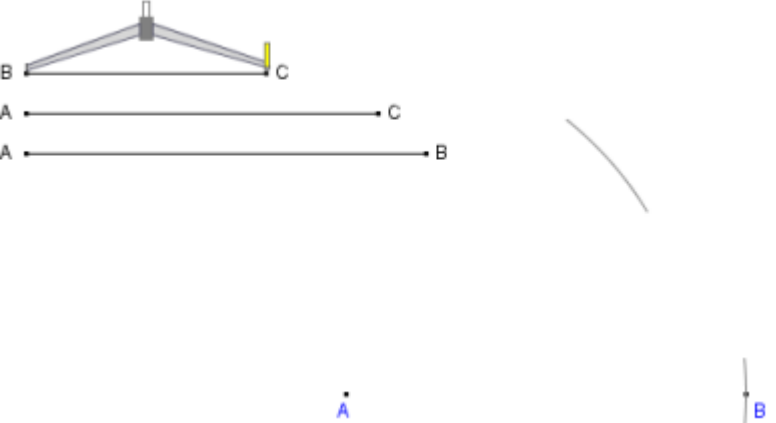

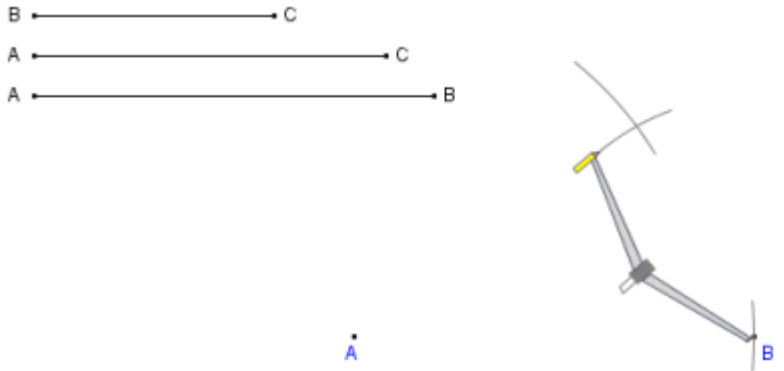
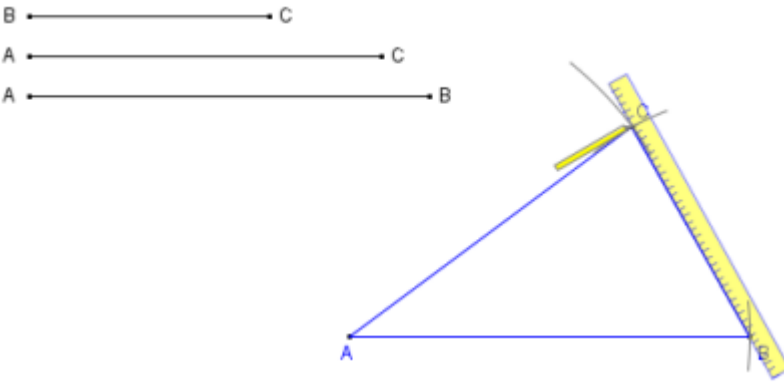
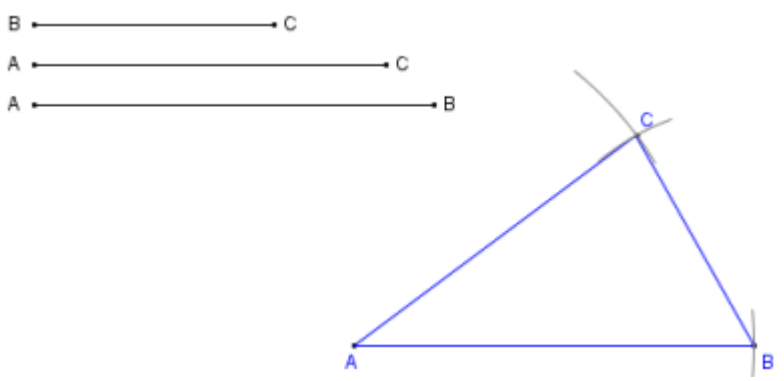

After doing this	Your work should look like this
<p>Start with three line segments that will be the three sides of the triangle ABC.</p>	
<p>1. Mark a point A that will be one vertex of the new triangle.</p>	
<p>2. Set the compass width to the length of the segment AB. This will become the base of the new triangle.</p>	
<p>3. With the compass point on A, make an arc near the future vertex B of the triangle.</p>	

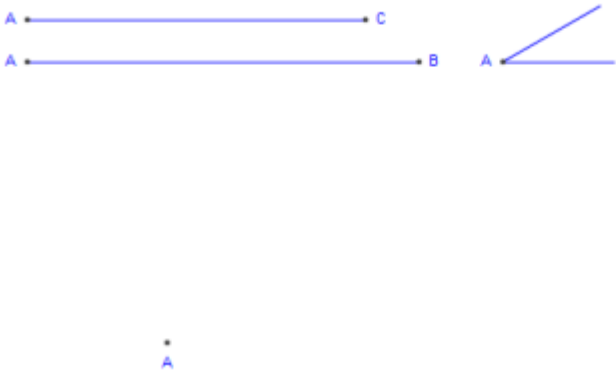

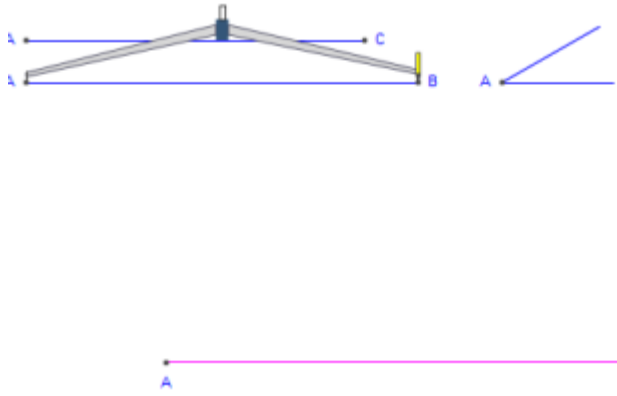

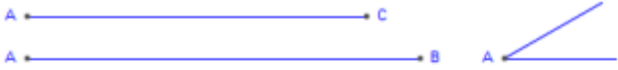
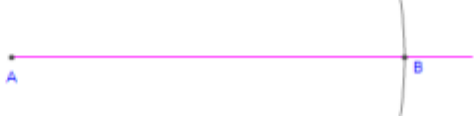
After doing this	Your work should look like this
<p>4. Mark a point B on this arc. This will become the next vertex of the new triangle.</p>	
<p>5. Set the compass width to the length of the line segment AC.</p>	
<p>6. Place the compass point on A and make an arc in the vicinity of where the third vertex of the triangle (C) will be. All points along this arc are the distance AC from A, but we do not yet quite know exactly where the vertex C is.</p>	
<p>7. Use the compass to measure the length of the segment BC, the length of the third side of the triangle.</p>	

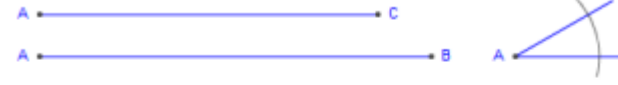
After doing this	Your work should look like this
<p>8. From point B, draw an arc crossing the first. Where these intersect is the vertex C of the triangle</p>	
<p>9. Finally, draw the three sides AB, AC, and BC of the new triangle.</p>	
<p>10. Done. The blue triangle ABC has each side congruent to the the corresponding line segment.</p>	

11. Triangle given two sides and included angle (SAS):

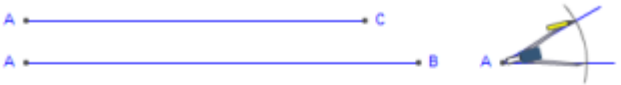
After doing this	Your work should look like this
<p>Start with two line segments and the included angle.</p>	
<p>1. Mark a point A that will be one vertex of the new triangle.</p>	
<p>2. Draw a ray from point A. This will become the side AB of the new triangle, so make it longer than AB.</p>	
<p>3. Set the compass width to the length of the given side AB.</p>	

After doing this	Your work should look like this
<p>4. Set the compass on A, and mark a point B on the ray just drawn.</p>	 
<p>5. With the compass set to any convenient width, from the point A on the given angle, draw an arc across both lines..</p>	 
<p>6. Without changing the compass width, draw a similar sized arc at point A on the new triangle.</p>	 

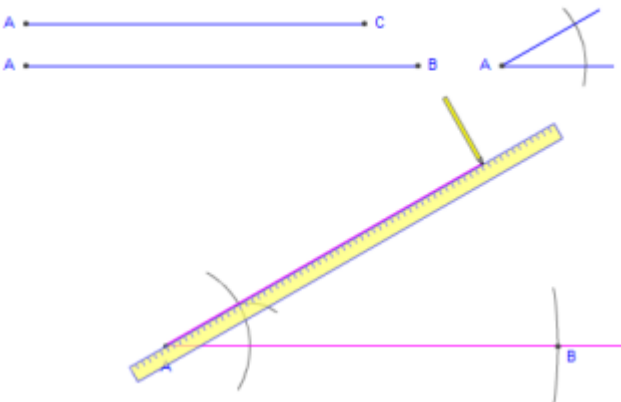
After doing this	Your work should look like this
<p>7. Set the compass to the arc width at the given angle A. This the distance between the points where the arc intersects the sides of the angle.</p>	 
<p>8. Make a similar arc on the new triangle so it crosses the previous arc.</p>	 
<p>9. Draw a ray from A, through where the arcs intersect and onwards. This will become side AC of the triangle so make it longer than AC.</p>	

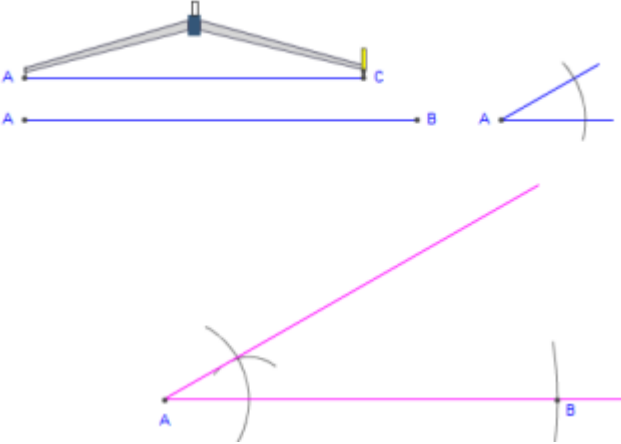
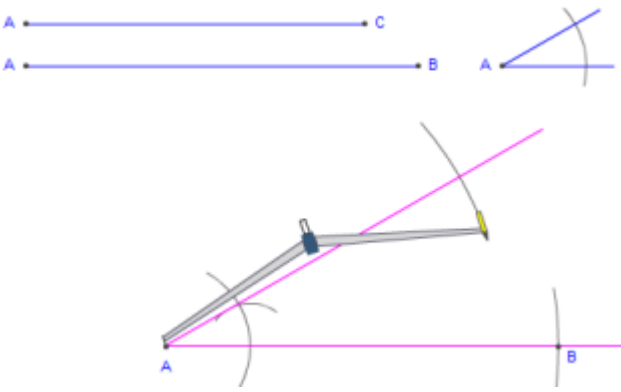
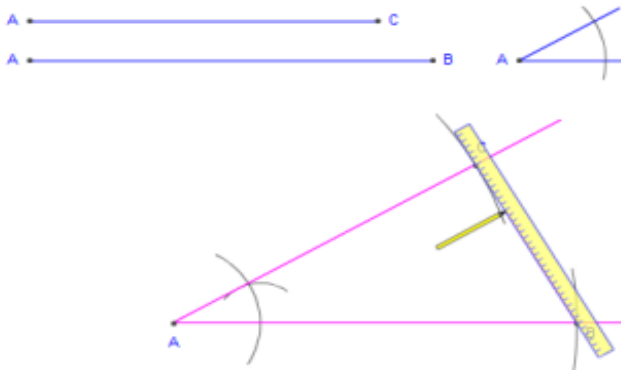
After doing this	Your work should look like this
<p>10. Set the compass width to the distance AC.</p>	
<p>11. With the compass on A, make an arc across the second ray, creating point C.</p>	
<p>12. Draw the line BC, the third side of the triangle</p>	

After doing this

Done, the triangle ABC has the desired two side lengths and included angle.

Your work should look like this

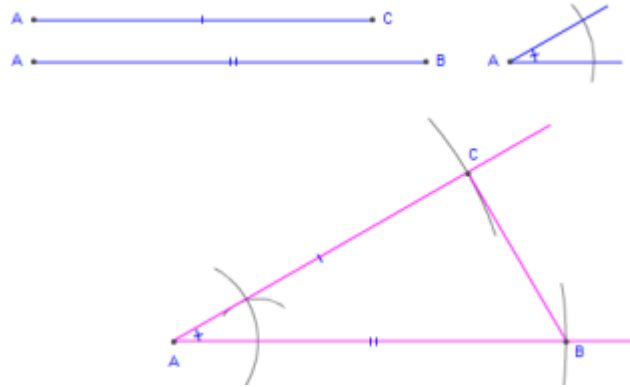

12. Triangle given two angles and included side (ASA):

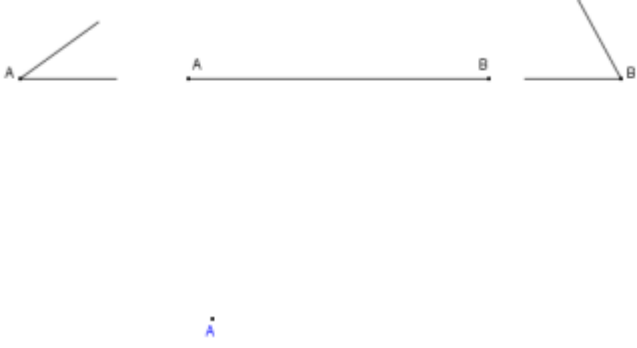
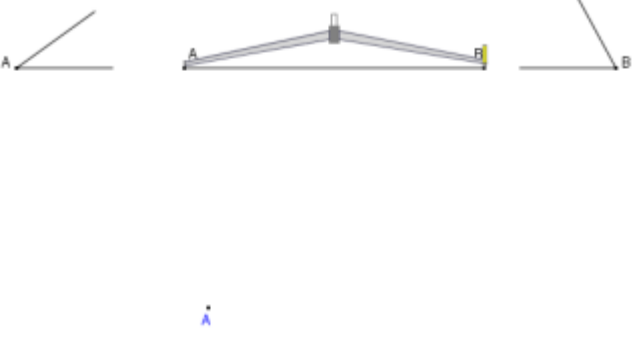
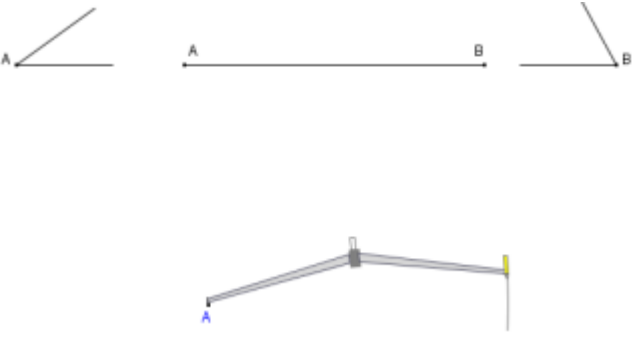
After doing this	Your work should look like this
<p>Start with the given line segment and two angles.</p>	 <p>Note: The two given angles are only there to indicate the <i>measure</i> of the two angles. The lines making up the given angles have random lengths that have no significance in the construction.</p>
<p>The first part of this construction (steps 1 - 4) is to copy a line segment to form one side of the new triangle. (See Copying a Line Segment).</p>	
<p>1. Mark a point A that will be one vertex of the new triangle.</p>	
<p>2. Set the compass width to the length of the segment AB.</p>	
<p>3. With the compass point on A, make an arc near the future vertex B of the triangle.</p>	

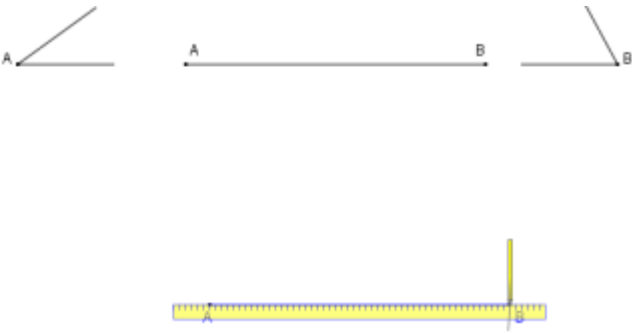
After doing this	Your work should look like this
<p>4. Mark a point B on this arc. Then draw the line AB. This will be one side of the new triangle.</p>	

What we do now is essentially copy the two angles. (See [Copying an Angle](#)).

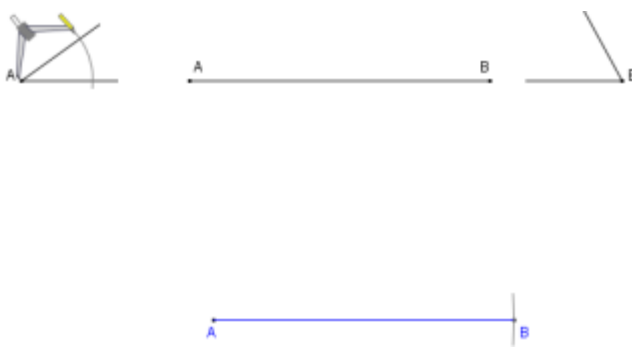

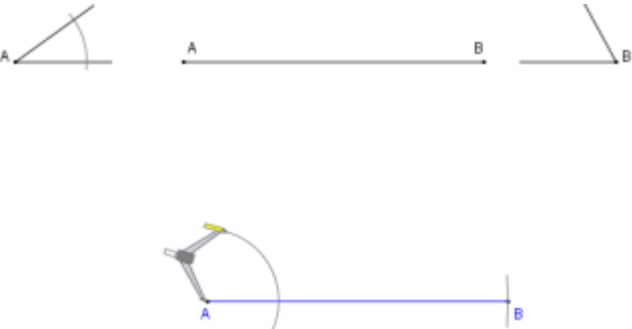
<p>5. With the compass at any convenient width, draw an arc across both lines of the given angle A.</p>	
---	---

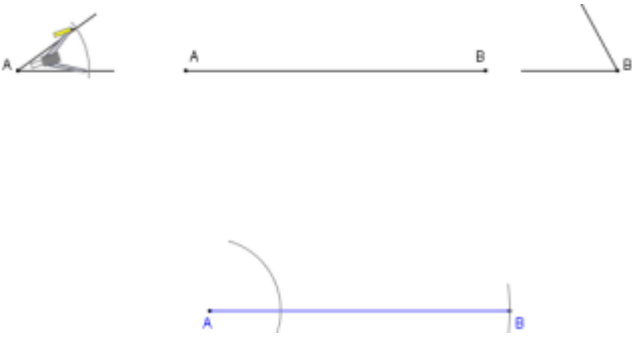
<p>6. Without changing the compass width, draw an arc at point A on the new triangle. The arc must cross AB and also cross the future side of the triangle.</p>	
---	--

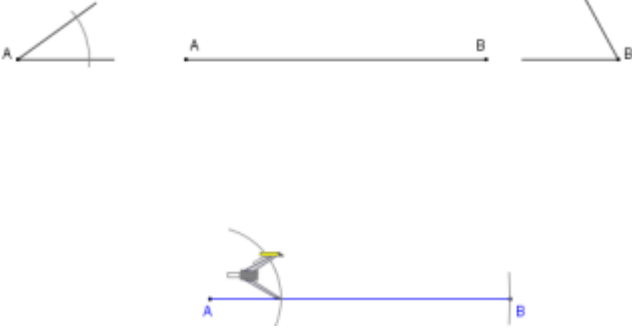
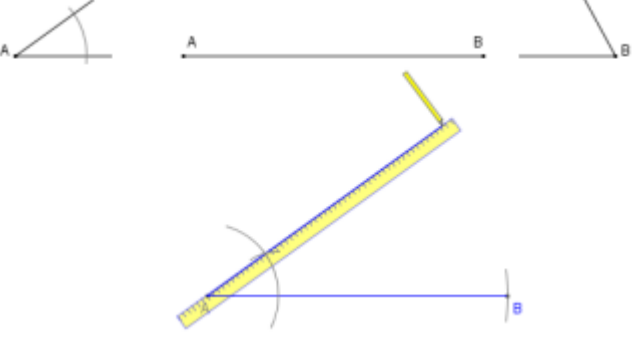
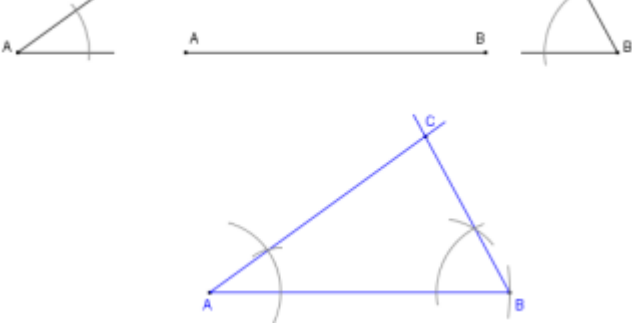

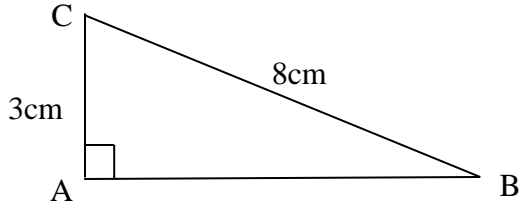
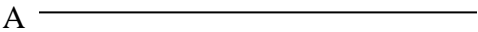
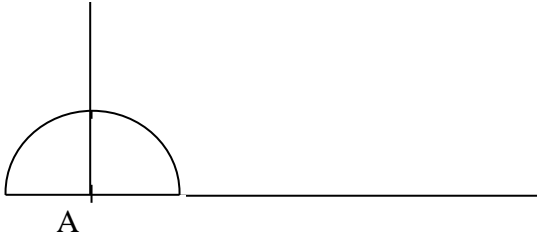

<p>7. Set the compass to the arc width at the given angle A. This is the distance between the points where the arc intersects the sides of the angle.</p>	
---	--

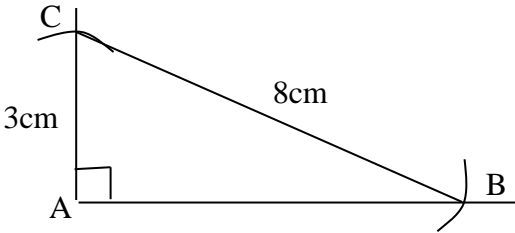
After doing this	Your work should look like this
<p>8. Near point A draw an arc in a similar position so it crosses the arc drawn earlier. This, in effect, 'copies' the measure of the angle at P to the angle at A.</p>	
<p>9. Draw a line from A through the point where the arcs intersect. This will become the second side of the triangle. Draw it long.</p>	
<p>10. Repeat this process at B. Copying the angle measure from the given angle B to the new triangle at B. The point where the lines intersect is C, the third vertex of the triangle.</p>	
<p>Done. The blue triangle ABC has the side and two angle measures desired.</p>	

13. Right-angled Triangle given length of hypotenuse and one other side:

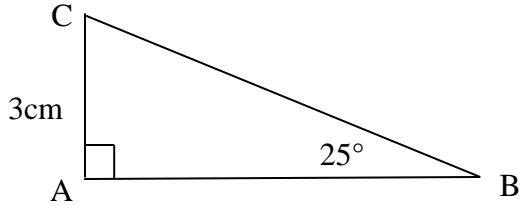
After doing this	Your work should look like this
<p>Draw a rough sketch of the triangle first.</p>	
<p>1. Draw a line segment to represent the base, using a ruler. Label the left most point of the line segment A.</p>	
<p>2. Place your protractor at point A and draw a line at an angle of 90°.</p>	
<p>3. Using a ruler, or a compass, mark off a distance of 3cm on the perpendicular line and call the point C.</p>	
<p>4. Set your compass to a length of the hypotenuse (8cm). Place the needle at C and mark off an arc on the line segment. Label the intersection B.</p>	
<p>5. Join C to B to complete the triangle.</p>	

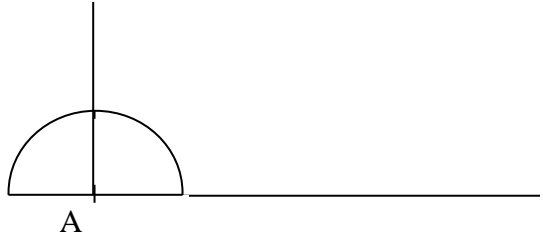
14. Right-angled Triangle given one side and one of the acute angles:

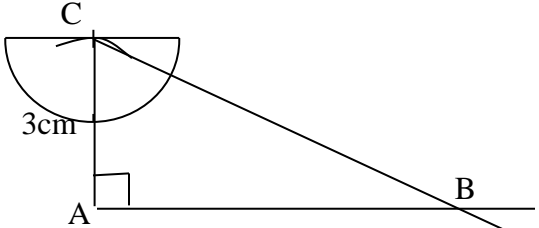
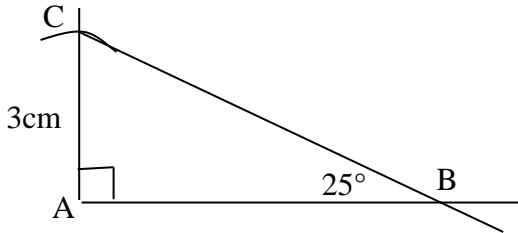
After doing this	Your work should look like this
<p>Draw a rough sketch of the triangle first.</p>	
<p>1. Draw a line segment to represent the base, using a ruler. Label the leftmost point A.</p>	
<p>2. Place your protractor at point A and draw a line at an angle of 90°.</p>	
<p>3. Using a ruler, or a compass, mark off a distance of 3cm on the perpendicular line and call the point C.</p>	
<p>4. If $\angle ABC = 25^\circ$, that means $\angle ACB = 65^\circ$. Place your protractor upside down at the point C and draw a line at 65° as shown. Label the third point of the triangle B as shown.</p>	
<p>5. The triangle required is now complete with an angle of 25° at B.</p>	

15. **Rectangle:**

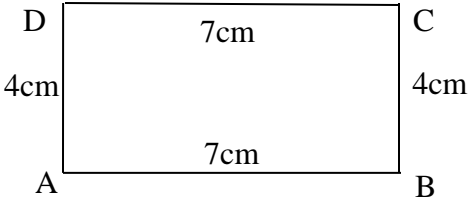
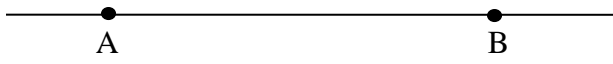
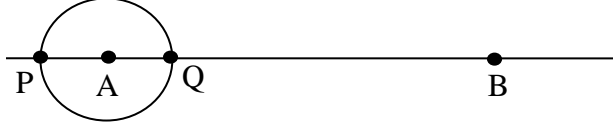
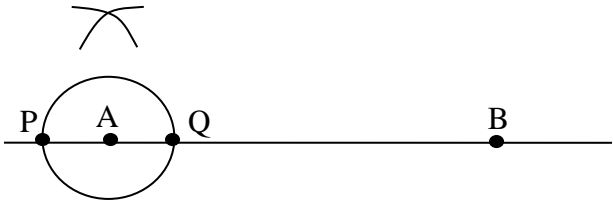
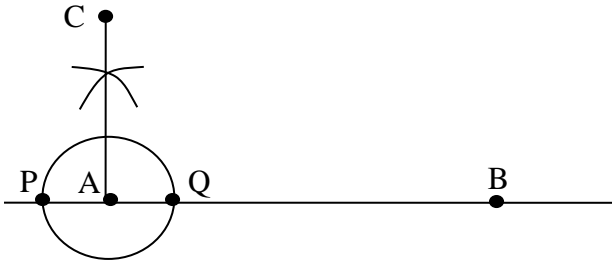
After doing this	Your work should look like this
<p>Draw a rough sketch of the rectangle first.</p>	
<p>1. Using a ruler, draw a horizontal line longer than 7cm in length. Using a ruler, mark off a line segment [AB] measuring 7cm. Label the end points A and B.</p>	
<p>2. Set your compass to a small radius and using A as a centre, draw a circle as shown. Label the two points where the circle crosses the line as P and Q as shown.</p>	
<p>3. Place your compass needle at points P and Q and swing two arcs as shown.</p>	
<p>4. Using your ruler, draw a line from A through the intersection point of the two arcs of length 4cm. Mark the point C at the end of the line segment just drawn.</p>	
<p>5. Repeat steps 2, 3 and 4 at point B. Join C to D to complete the rectangle.</p>	